

Flexible high-mix production



AIMEX III **AIMEX IIIc**



BEST

Introducing the best configuration for high-mix production

- Industry leader in loadable parts quantity, with up to 130 part supply positions.
- Is the best choice for any type of production, with the flexibility to support part type changes.
- Supports from very small parts to large parts with one machine.
- Allows for ease when ramping up new production or when responding to errors if they occur.

MATCH

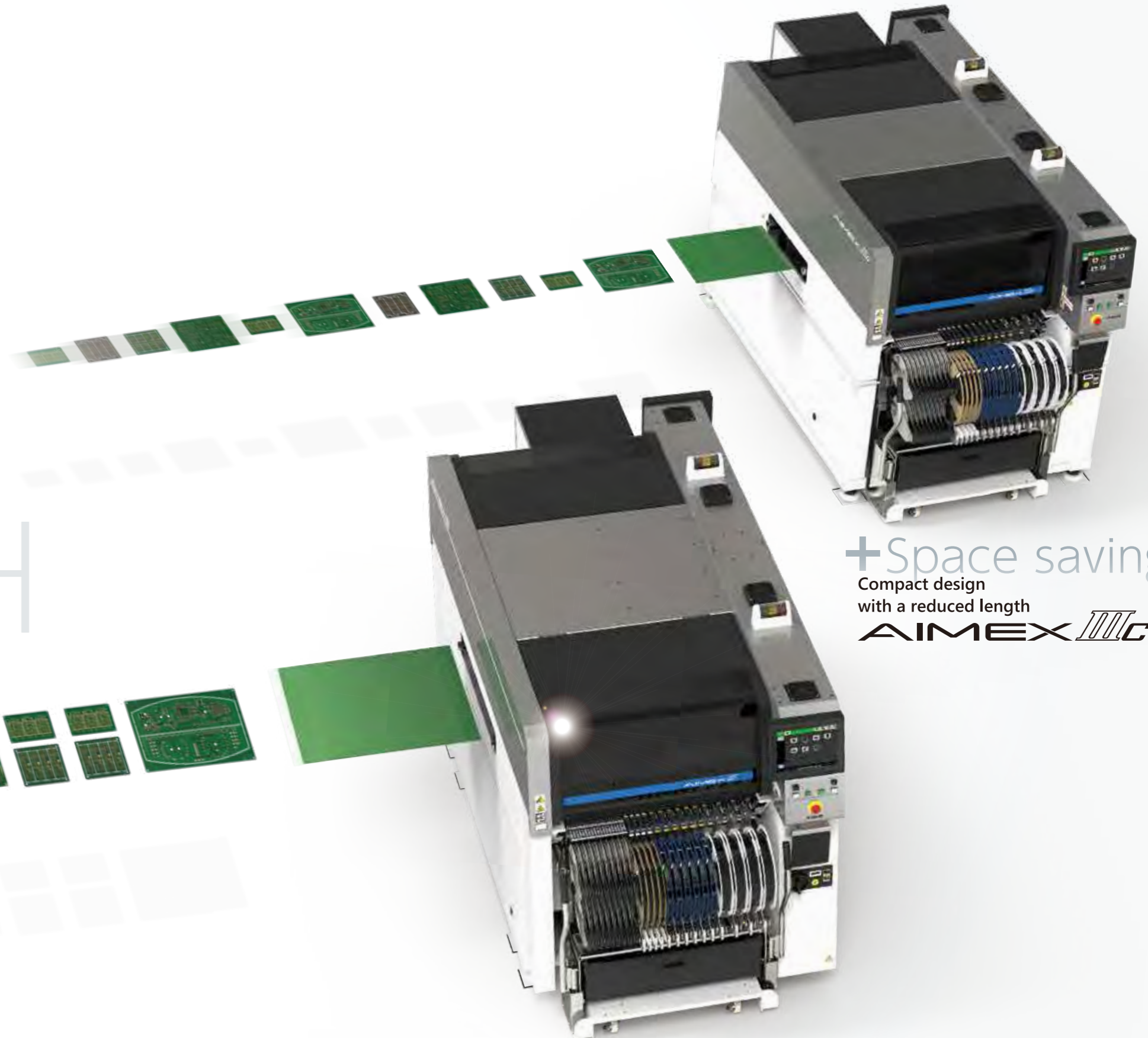

+ Space saving
Compact design
with a reduced length
AIMEX III C



Versatility

Flexibly supports high-speed placement of chip parts, as well as high-mix production using many large parts and odd-form parts.



High quality

Multiple types of checks prevent defects from occurring.



Simple

The time and effort required is reduced drastically through benefits such as the reduction of the number of changeovers. Operation is easy, and ramping up of production progresses smoothly.

+ High capability
Supports production for large panels and
simultaneous production of two models
AIMEX III C

01 Versatile capability for enabling high-mix production



■ Supporting 0402 (01005") to 102 x 102 mm parts placement and glue application by one head

A DX head exchanges the dedicated tool in one action depending on the part size, from small chips to large odd-form parts. A glue tool enables the machine to perform glue application in addition to parts placement.

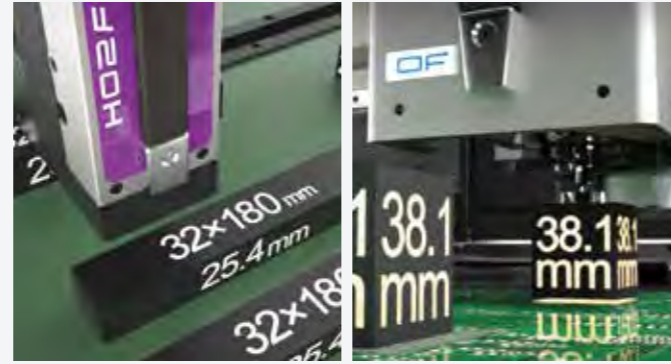

■ Placement and pressure insertion for larger parts and odd-form parts

Using an OF head and tray unit-LTW2 combination supports parts with a height of up to 1.5 inches (38.1 mm) and pressure insertion of up to 98 N. Large and odd-form parts can be handled using nozzles and mechanical chucks.



■ Supporting a wide variety of parts

This machine supports various types of part supply packages, from tape parts to tray and stick supplied parts, meeting the needs of high-mix production.



■ Place a large volume of very small parts in a short time

This machine can be loaded with H24S heads for placing 0201 mm parts with an accuracy of ± 0.025 mm. With the two head configuration, the machine can reach up to 80,000 cph using productivity priority mode.

3 key points
Three key points when choosing the best machine for high-mix production

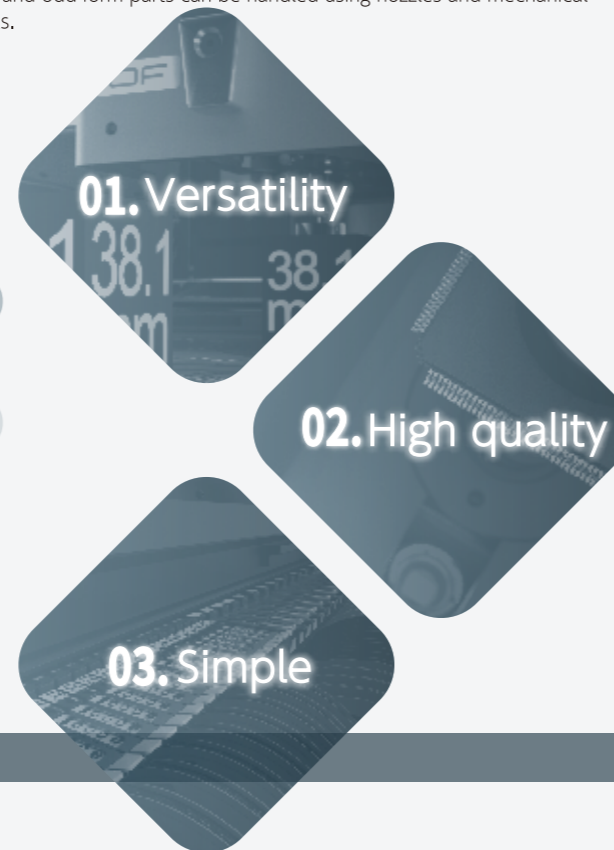

02 Functions supporting high quality placement

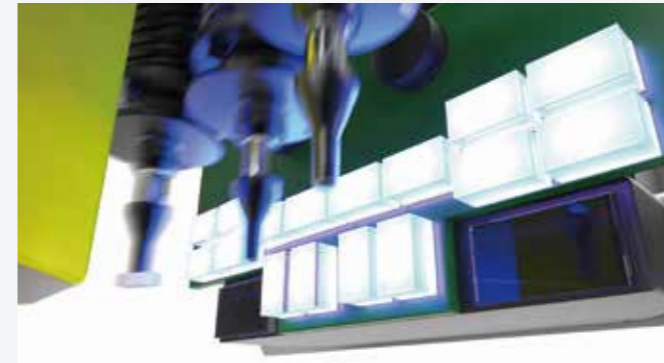

■ Checking every part at full-speed (IPS)

This IPS can cater to a wide range of checks, from part pickup stance to parts remaining on nozzles, as well as upside-down checks for minimold parts. High-speed vision processing sustains placement quality without any drop in throughput. (Option for some heads)

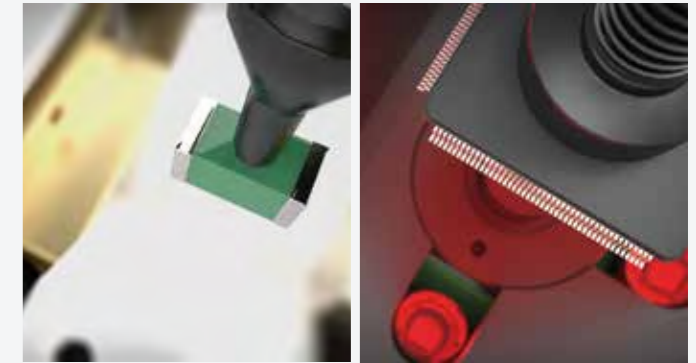

■ Eliminating placing defects through multiple checks

High quality placement is achieved with one machine by preventing defects before they can occur through the use of LCR checks, coplanarity checks for leads and bumps of parts such as IC devices. (Option)

03 Simple functions for handling various part types with ease



■ Minimizing the changeover count

Changeover time can be reduced by performing MFU batch changeover and by the machine having up to 130 slots for feeders which makes it possible to load all of the required parts.



■ Flexible optimization to match your operation methods

Optimization becomes more flexible using Nexim optimizer as practical operation methods are taken into account. This includes grouping production programs to minimize the number of changeovers, performing batch exchange of feeders using an MFU, and changeovers which are performed without stopping production.



■ Ramping up production smoothly

Automatic data creation and on-machine editing using a large touchscreen panel to support ramping up new production and quick response to sudden changes to programs.



■ Faster part data creation tool, ASG 2.0

ASG 2.0 (Auto Shape Generator 2.0) improves the performance by 42 % compared to its previous version. This expands the capability of creating data automatically even for parts with unique shapes that have not been supported in the past. The on-machine ASG, the function to update part shape data on the machine, is now compatible with ASG 2.0 and further reduces the time required for adjustment.

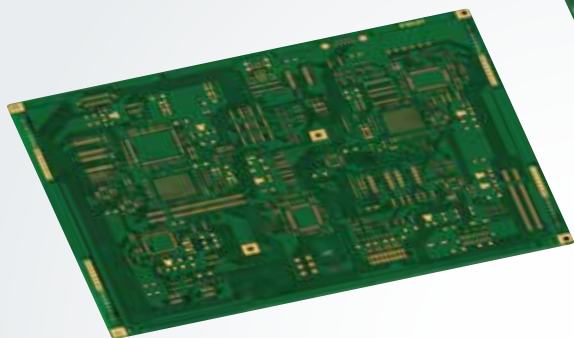

Large panel production

Single conveyor configurations can support production for large panel up to 1,068 x 710 mm.

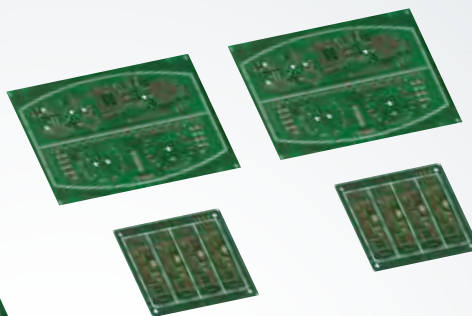
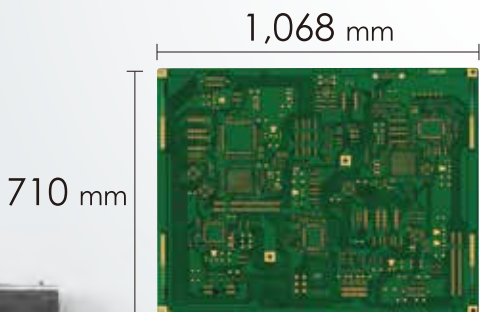

Simultaneous production of two models

Double conveyor configurations enable a variety of operations depending on your production type.

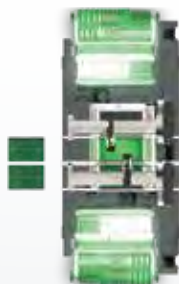

Dual lane production with same model

Produces for same model efficiently in a short time.



Dual lane production using different models

Produces different models on each lane simultaneously.



Multi production

Produces for different models at side 1 and side 2 independently.



+ High capability AIMEX III

Handles large panels and improves productivity with the simultaneous production of two models

Supports various production types with separate use of single and double conveyors

Sample machine configurations

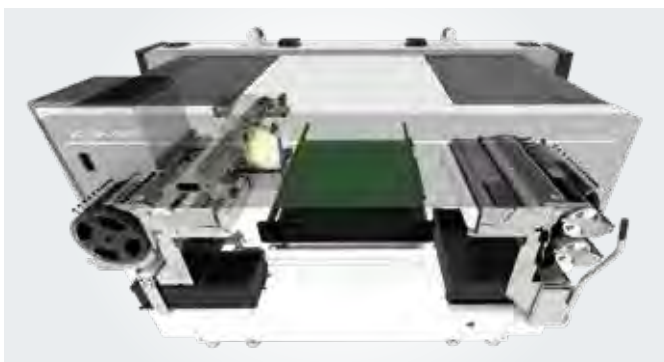

Large panel production (single robot with single conveyor)

- DX x 1
- MFU65 II x 1
- Tray unit-LTW2 x 1
- Single conveyor

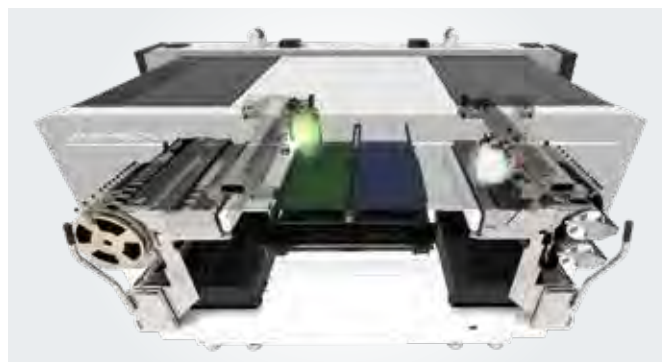

Simultaneous production of two models (twin robots with double conveyors)

- DX x 2
- MFU65 II x 2
- Double conveyor

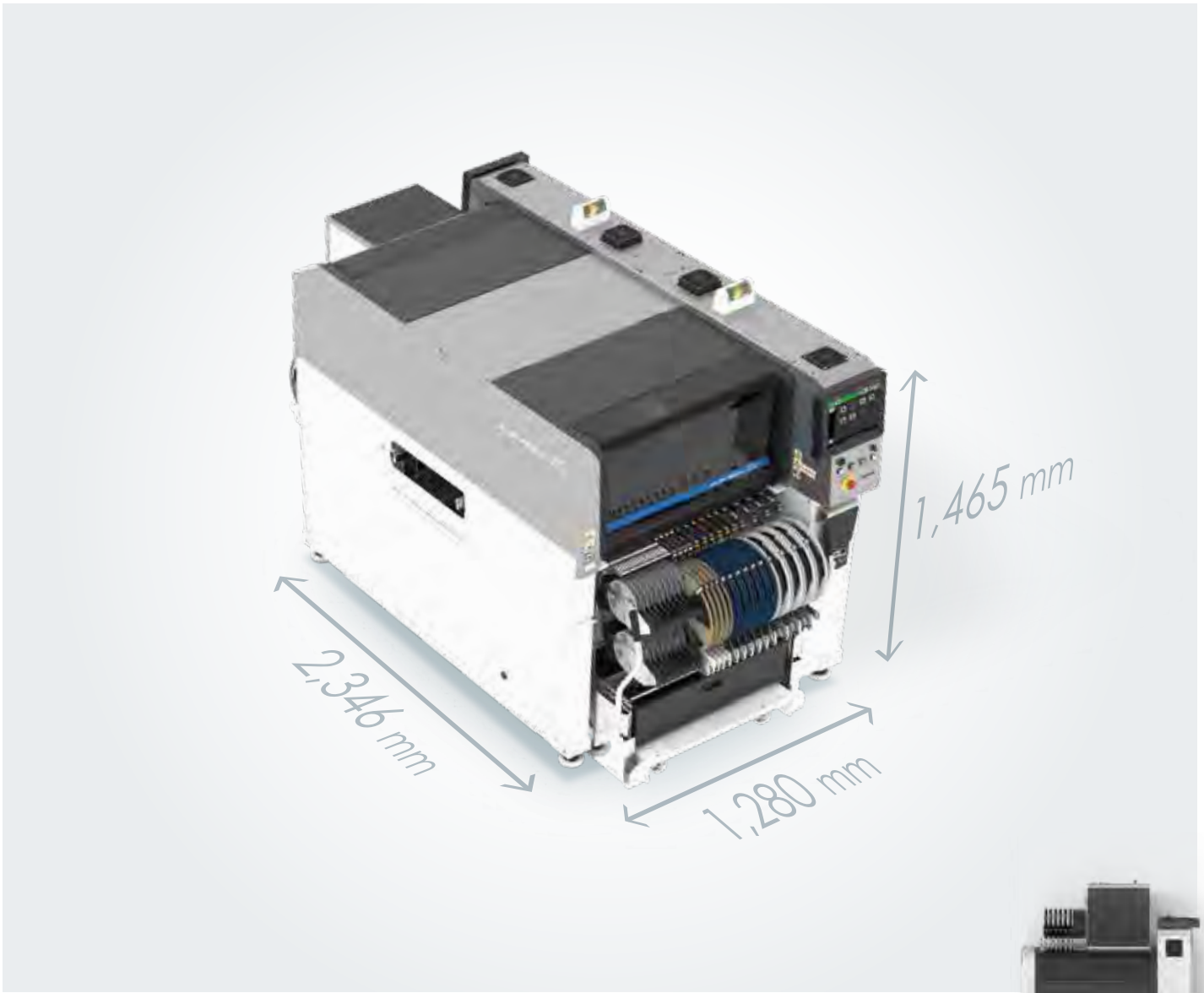

+ Space saving **AIMEX III C**

Frees up more floor space with its compact design and reduced length

Makes your high-mix production compact with a simple single conveyor configuration



Sample machine configurations

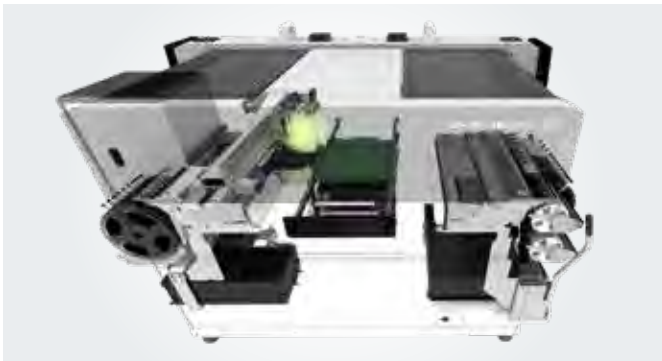

■ Simple high-mix production

- DX x 1
- MFU65 II x 1
- Tray unit-LTW2 x 1
- Single conveyor

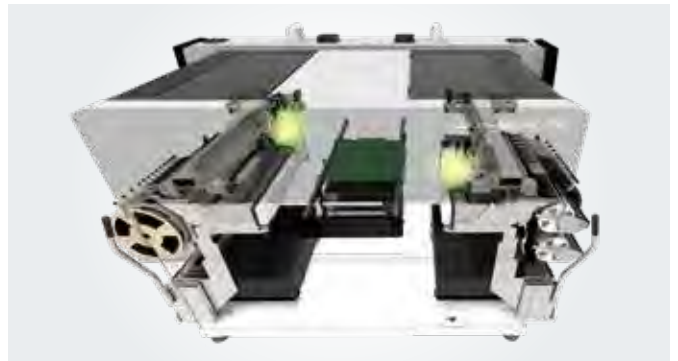

■ High-speed chip shooter

- H24S x 2
- MFU65 II x 2
- Single conveyor

Overview

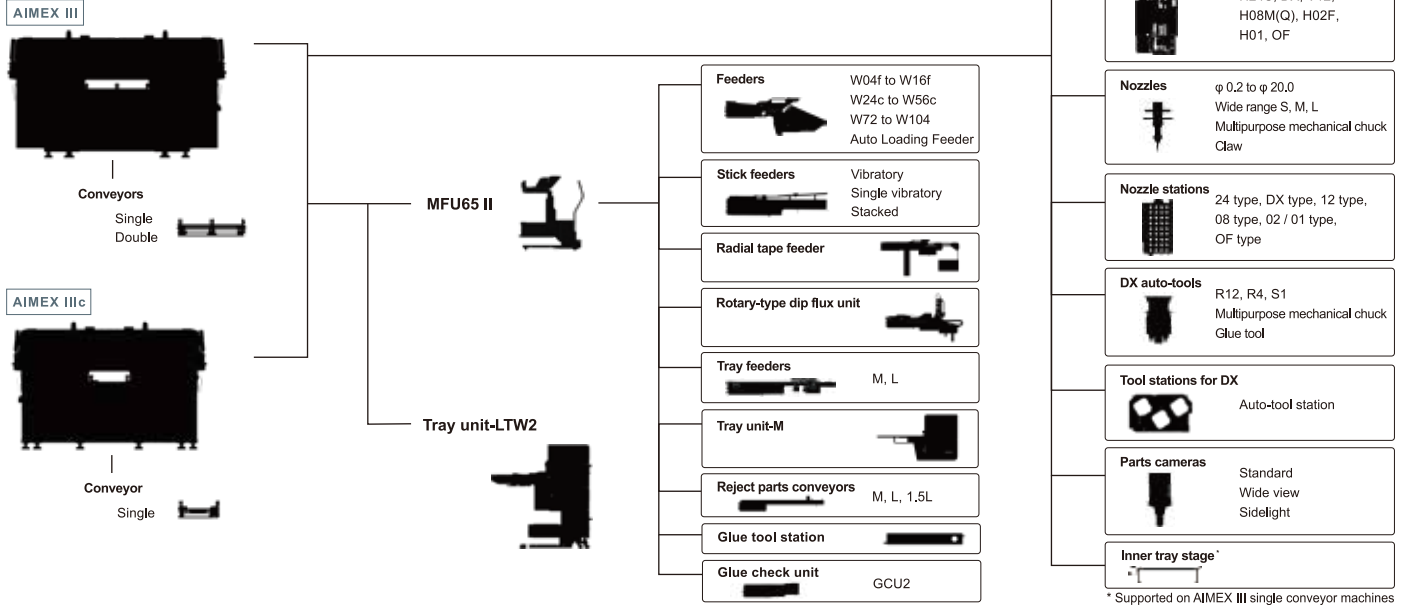

External dimensions

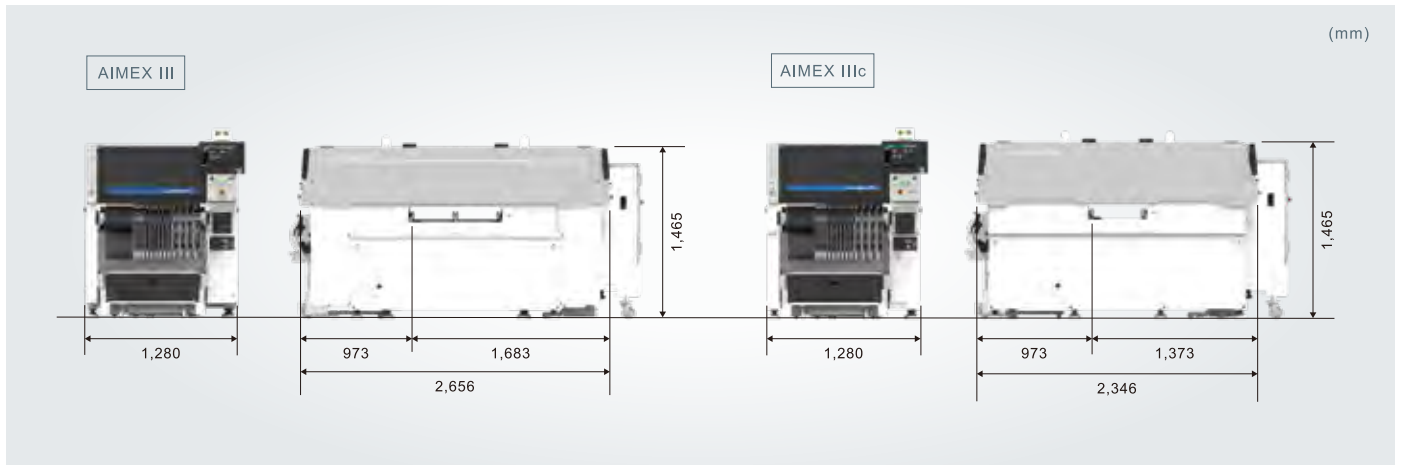

Specifications

Machine			AIMEX III		AIMEX IIIc				
Feeder slot quantity			130						
Panel size (L × W)	Single conveyor		48 × 48 to 1,068 × 710 mm ^{*1}			48 × 48 to 508 × 400 mm			
	Double conveyor	Single conveyance	48 × 48 to 1,068 × 610 mm			-			
		Dual conveyance	48 × 48 to 1,068 × 330 mm			-			
Power source			3-phase 200 to 230 V ±10% (50/60 Hz)						
Air			0.5 MPa (ANR)						
Air consumption	Single robot		40 L/min (ANR)						
	Twin robot		60 L/min (ANR)						
Weight	Single robot		1,490 kg			1,370 kg			
	Twin robot		1,720 kg			1,530 kg			
Heads			H24S, DX, V12, H08M(Q), H02F, H01, OF						
Throughput ^{*2}	Head type	H24S	DX				H08M(Q)		
			R12 (12 nozzles)	R4 (4 nozzles)	S1 (Single nozzle)	Glue tool ^{*3}			
			Normal mode	35,000 cph	27,000 cph	12,000 cph		5,800 cph	0.40 sec/shot
			Productivity priority mode	40,000 cph	-	-	-	-	14,000 cph
Placing accuracy ^{*2} (Application position accuracy)	Normal mode		±0.025 mm	±0.038 mm	±0.040 mm	±0.030 mm	±0.100 mm	±0.040 mm	

*1 Support for panels up to 1,500 × 710 mm is available as an option.
*2 Under optimum Fuji conditions.
*3 Option

FUJI CORPORATION

19 Chausuyama, Yamamachi, Chiryu, Aichi, 472-8686 Japan

Tel : +81 566 81-2110
Fax: +81 566 83-1140

- Details in this document are subject to change without notice due to constant product development.
- Information in this catalog is current as of February 2022.
© 2022 FUJI CORPORATION. All Rights Reserved.